

LIGHTS

ITALIAN AESTHETIC

MYYOUR®

L I
G H
T S

ITALIAN AESTHETIC

INDEX

Piantane
Standing lamps

Joy
12 - 21

Hollywood
22 - 29

Penelope
32 - 37

Agata
38 - 47

Agata Wood
48 - 53

Ampoule XL
54 - 59

Tulip XL
62 - 69

Baby Love
78 - 79

Pandora
86 - 95

Elin
112 - 113

Sospensioni
Suspension lamps

Hollywood
30 - 31

Baby Love
82 - 83

Pandora
96 - 99

Elin
104 - 111

Nefos
114 - 119

Funnel
120 - 129

Bell
130 - 139

Crystal
152 - 153

Lampade da terra
Floor lamps

Pandora
100 - 101

Crystal
146 - 151

Treesmust
154 - 159

Lampade da tavolo
Table

Ampoule S
54 - 59

Tulip S
62 - 69

Baby Love
84 - 85

Bonsai
140 - 145

Light Tales
160 - 167

Galleggianti
Floating lamps

Baby Love
72 - 75

Pandora
102 - 103

Lampade da muro
Wall lamps

Baby Love
80 - 81

Tech index
Designer

Tech Index
168 - 169

Designer
174 - 175

MY YOUR IS

Myyour è passione per il design, per la ricerca, fra linea e tecnologia, per competere nel mercato worldwide, sempre più esigente e in continua espansione.

Una vita nel colore, nella forma positiva, giocosa ed eccellente della materia plastica. Un team dinamico, preparato ed efficace per rispondere ad ogni richiesta del Cliente.

Un'azienda giovane, in cui l'interazione fra tecnologia ed esperienza trentennale nel settore delle materie plastiche, risulta essere la vera forza della libertà creativa, della diffusione e dell'eccellenza nel processo produttivo.

Myyour è, dopo dieci anni dalla sua fondazione, un'azienda consolidata, una coesione fra saper fare e un'identità in costante mutamento, sempre pronta ad accogliere nuovi trend, nuove esperienze creative per ogni esigenza, indoor e outdoor, dell'abitare.

Myyour is passion for design, research, between line and technology, to compete in a global market, increasingly demanding and ever expanding.

A life in color, in the positive, playful and excellent form of plastic material. A dynamic team, prepared and efficient to respond to every need of the Customer.

A young company, in which the interaction between technology and decades of experience in the plastics sector, appears to be the real strength of creative freedom, the spread and excellence in the industrial production.

Myyour is, after ten years since its foundation, established company, a cohesion between know-how and identity constantly changing, always ready to welcome new trends, new creative experiences for every need, indoor and outdoor living.

Myyour lights nasce dall'esigenza di valorizzare i prodotti luminosi già presenti nelle collezioni e dar loro un ruolo da protagonista nel palcoscenico del design contemporaneo.

Grazie alla tecnologia di produzione rotazionale, Myyour riesce a creare forme che nell'immaginario collettivo ci si aspetta in materiali diversi dal polietilene.

Quest'ultime sono iconiche e sposano perfettamente la luce, siano esse associate ad una lampada classica o ad elementi che mai ci si sarebbe aspettati di trovare illuminati.

La ricerca infine di finiture speciali come l'ossidato e il direct painting, già di successo per Myyour nell'arredamento da esterno, impreziosisce ulteriormente gli articoli accontentando le esigenze dei palati più fini.

Myyour lights is born from the need to enhance the lighting products already present in the collections and give them a leading role in the stage of contemporary design.

Thanks to the rotational production technology, Myyour is able to create shapes that in the collective imagination are expected in materials other than polyethylene.

The shapes are iconic and perfectly match the light, whether they are associated with a classic lamp or elements that one would never expect to find enlightened.

Finally, the search for special finishes such as oxidized and direct painting, already successful for Myyour in outdoor furniture, further embellishes the items satisfying the needs of the finest palates.

L I G H T S

ITALIAN AESTHETIC





JOY

Il vero protagonista di JOY è il Poleasy, materiale illuminato ed esaltato dall'accostamento con materiali preziosi ed inaspettati per il mondo dell'outdoor.

JOY, con la base in marmo e le sue perle di luce sorrette dall'asta di metallo con finitura rame, prende ispirazione dal mondo del gioiello classico ma è reso più contemporaneo da organiche superfici realizzate grazie a strumenti di modellazione digitale ed esaltate dal materiale plastico.

Le perle, grazie ai diversi supporti, permettono di declinare la lampada in vari formati e di adattarla a diversi contesti e funzioni: da importanti composizioni architettoniche fino al semplice punto luce.

Un gioiello di luce dalla grande presenza e dall'infinita grazia.

JOY's real protagonist is Poleasy, a lighted material exalted from the combination of valuable and unexpected materials regarding the outdoor world.

JOY has a marble basis and light pearls sustained by a copper finishing metal pole. JOY takes inspiration from the classic jewels world but it's more modern thanks to organic surfaces carried out through digital modelling instruments and exalted by plastic.

Thanks to the different holders, the pearls enable the lamp to be combined in various formats and adapted to different contexts and functions: from significant architectural compositions to the simple light source.

A light jewel with great appearance and endless charm.





Piantana Joy
Joy standing lamp



Piantana Joy
Joy standing lamp



Standing lamp

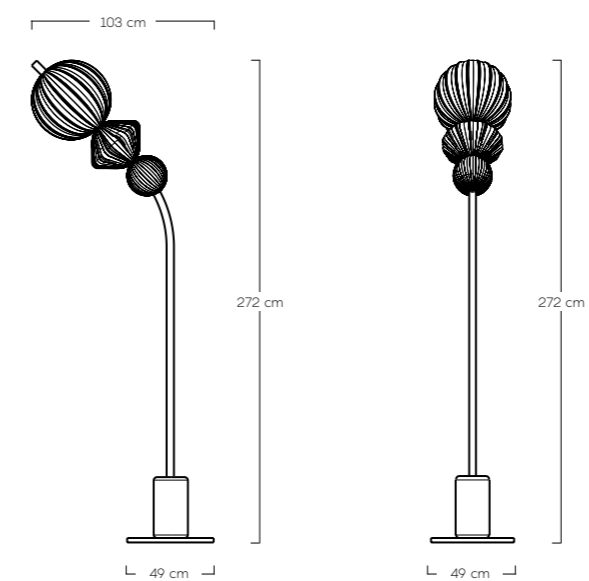

CE  IP44 

Material:
Poleasy
Methacrylate opal

Net weight:
40 kg

Volume packaging:

IP66 

Finishing e colours:
OV: 177 pearly copper

Base Finishing:
Trani

Cable length:
3 mt black cable with plug

Power Input:
110-270V 50/60Hz

Power Consumption:
45W

Light source:
Led

Characteristic:
3000K - 5000lm - CRI80



Standing lamp

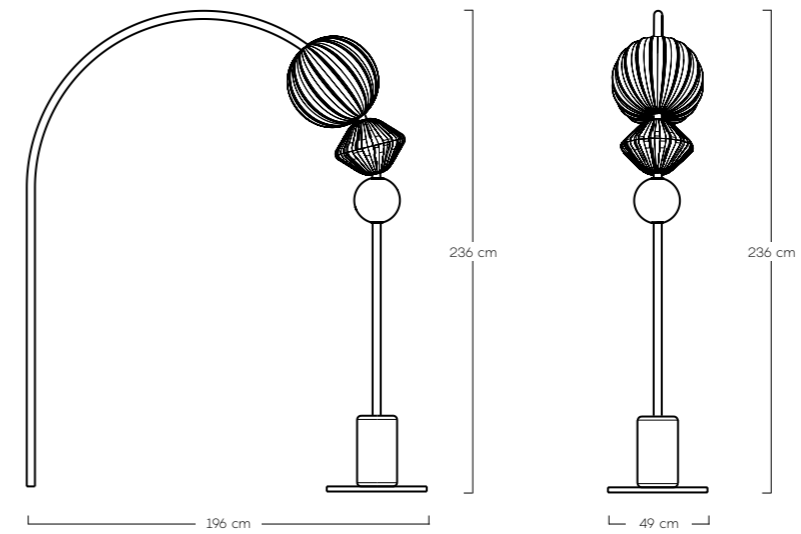

CE IP44

IP66

Material:
Poleasy
Methacrylate opal

Finishing e colours:
OV: 177 pearly copper

Cable length:
3 mt black cable with plug

Power Input:
110-270V 50/60Hz

Net weight:
40 kg

Base Finishing:
Trani

Power Consumption:
45W

Volume packaging:

Light source:
Led

Characteristic:
3000K - 5000lm - CR180

HOLLYWOOD

Lampada dal design iconico e riconoscibile, dalla forte identità ed unica nel suo genere, Hollywood caratterizza ogni ambiente grazie al suo suggestivo impatto scenico.

La possibilità di regolarne l'intensità luminosa e l'orientabilità del corpo illuminante la rende una lampada trasversale e adattabile a varie situazioni: può illuminare un'area lounge, una parete o il soffitto, può caratterizzare l'ingresso di un locale o essere affiancata tanto ad un divano quanto ad un'area lettura.

La lampada Hollywood, con il suo mood "fashion-industrial", conferisce ad ogni ambiente un sapore di set cinematografico, nel quale sentirsi dei protagonisti sotto i riflettori.

Lamp with an iconic and recognizable design, with a strong identity and unique in its kind, Hollywood characterizes every location thanks to its evocative scenic impact.

The possibility of adjusting the light intensity and the directionality of the lighting body makes it a transversal lamp that can be adapted to various situations: it can illuminate a lounge area, a wall or ceiling, it can characterize the entrance of a room or it can be placed next as to a sofa as to a reading area ...

The Hollywood lamp, with its "fashion-industrial" mood, confers to every location a taste of film set, in which feeling the main character in the spotlight.





Piantane Hollywood
Hollywood standing lamps

Modi Zero divani e tavoli - catalogo Aesthetic
Modi Zero sofas and tables - Aesthetic catalogue



Piantane Hollywood
Hollywood standing lamps



Standing lamp

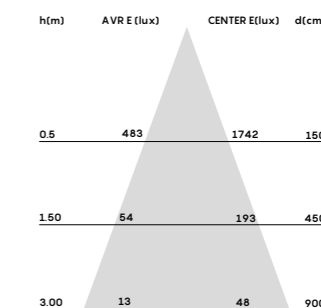
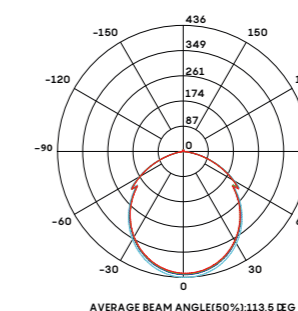
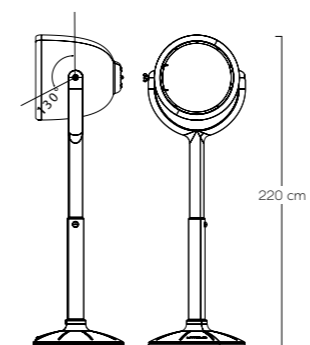

CE IP44

Material:
Poleasy
Methacrylate opal

Net weight:
18 kg

Volume packaging:
1,15 mc

IP66

Finishing e colours:
GS: 117 white
92 brown
87 grey

OS: 500 rust
101 copper

OV: 180 pearl grey
162 dark pearl

Cable length:
3 mt black cable with plug

Switch:
Dimmable with remote control

Power Input:
110-270V 50/60Hz

Power Consumption:
33W

Light source:
Led plate

Characteristic:
3000K - 5000lm - CRI80

Standing lamp with battery

CE IP66

Power Input:
AC / DC 100 - 240V 50 / 60Hz

Power Output:
12V 28Ah lithium battery

Recharging and duration time:
8 - 10 h

Power Consumption:
33W

Light source:
Led plate

Characteristic:
3000K - 5000lm - CRI80

CE IP20

Recharging method:
Battery charger (IP20)
12V 5Ah



Suspension

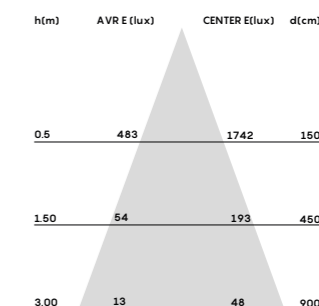
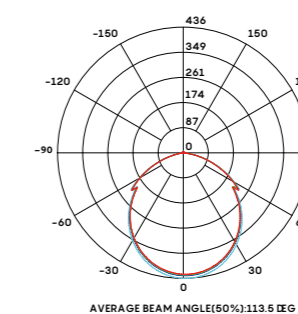
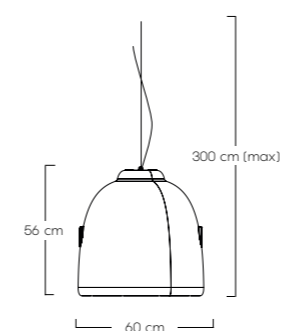

CE IP66

Material:
Poleasy
Methacrylate opal

Net weight:
7 kg

Volume packaging:
0,22 mc

Finishing e colours:
GS: 117 white
92 brown
87 grey

OS: 500 rust
101 copper

OV: 180 pearl grey
162 dark pearl

Cable length:
3 mt black cable + suspension
steel wire

Switch:
Dimmable with remote control

Power Input:
110-270V 50/60Hz

Power Consumption:
33W

Light source:
Led plate

Characteristic:
3000K - 5000lm - CRI80

Indoor rose ceiling detail



PEN ELO PE

Si ispira al mondo classico, ma sfoggia design, tecnologie e caratteristiche funzionali decisamente all'avanguardia.

Penelope di MYYOUR è fatta per stupire: per le dimensioni, per il design, per le proprietà funzionali e per le finiture essendo disponibile anche in ossidato.

It is inspired to the classic world, but it stands out for its avant-garde functional design, technology and features.

Penelope by MYYOUR intends to astonish: for its sizes, for its design, for its functional features and for the finishings being available also in oxidized.





Piantane Penelope
Penelope standing lamps



Standing lamp

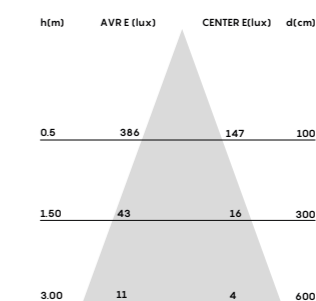
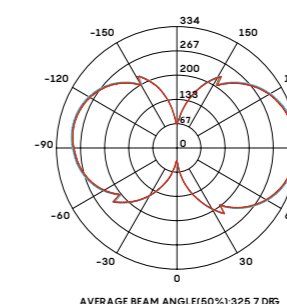
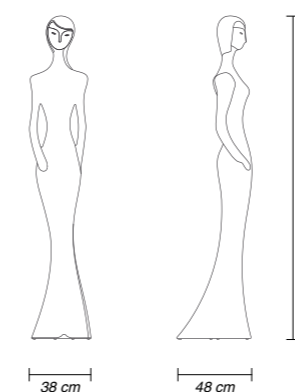

CE IP20

IP44

Material:
Poleasy

Finishing e colours:
IL: 110 trasparente

Net weight:
14,5 kg

Cable length:
2 mt white cable with plug

Power Input:
AC: 100-240V 50/60Hz
DC: 12V 5.0A

Volume packaging:
0,42 mc

Switch:
- ON/OFF switch fitted on the power cord (IP20)
- Plug (IP44)

Power Consumption:
60W

Light source:
Strip Led White
Strip Led RGBW

Characteristic:
6200 - 5000 lm - CRI80 (white)
6200 - 5000 lm - CRI80 (rgbw)

Standing lamp with battery

CE IP66

CE IP20

Power Input:
AC/DC 100-240V 50/60Hz

Power Consumption:
36W

Power Output:
12V 28Ah lithium battery

Light source:
Strip Led RGBW

Recharging time:
6-8 h.

Characteristic:
6500k - 3210lm - CRI80 (rgbw)

Duration time:
8-10 h.

Recharging method:
Battery charger (IP20)
12V 5Ah

AGGA
TAA

Si ispira al mondo classico, ma sfoggia design, tecnologie e caratteristiche funzionali decisamente all'avanguardia.

Penelope di MYYOUR è fatta per stupire: per le dimensioni, per il design, per le proprietà funzionali e per le finiture essendo disponibile anche in ossidato.

It is inspired to the classic world, but it stands out for its avant-garde functional design, technology and features.

Penelope by MYYOUR intends to astonish: for its sizes, for its design, for its functional features and for the finishings being available also in oxidized.







Piantane Agata
Agata standing lamps



Standing lamp E27

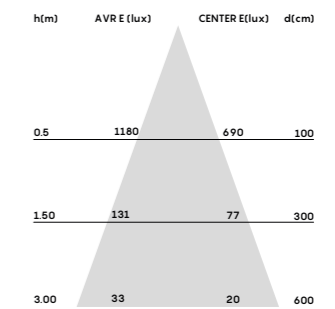
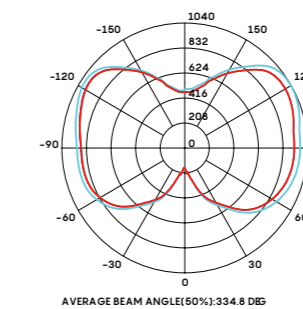
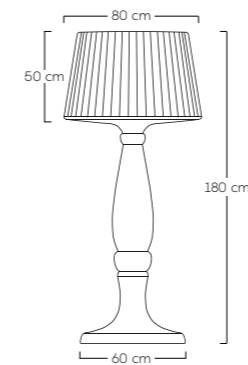

CE IP20

Material:
Poleasy

Net weight:
20 kg

Volume packaging:
1,24 mc

IP20 IP66

Finishing e colours:
IL: 110 trasparente

OS: 500 rust*
101 copper*

*la verniciatura può variare
l'intensità luminosa

Cable length:
2 mt white cable with plug

Switch:
- ON/OFF switch fitted on the
power cord (IP20)
- Plug (IP44)
- Connector box (IP66)

Power Input:
110-240V - 50/60 Hz

Power Consumption:
5x max 32W E27

Light source:
Bulb (diam. max 74mm)

Characteristic:
N.C.

Standing lamp LED

CE IP44

Material:
Poleasy

Net weight:
20 kg

Volume packaging:
1,24 mc

Finishing e colours:
IL: 110 trasparente

OS: 500 rust*
101 copper*

*la verniciatura può variare
l'intensità luminosa

Cable length:
2 mt white cable with plug

Switch:
Plug (IP44) or connector box
(IP66)

Power Input:
AC: 100-240V 50/60Hz
DC: 24V 40W

Power Consumption:
28W

Light source:
Led plate and strip white

Characteristic:
3000K - 4200lm - CRI80 (white)



Standing lamp LED with battery

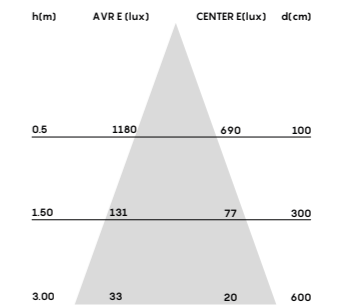
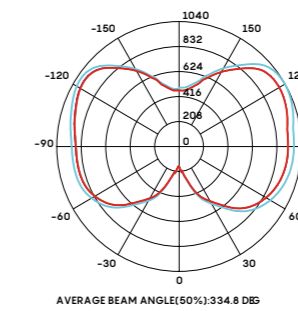
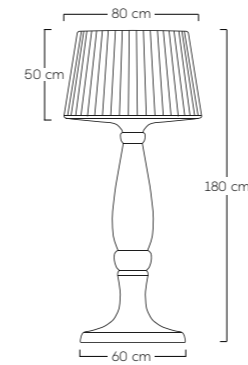

CE IP66

Power Input:
AC/DC 100-240V 50/60Hz

Power Output:
12V 28Ah lithium battery

Recharging time:
6-8 h

Duration time:
8-10 h

Power Consumption:
28W

Light source:
Led plate and strip white

Characteristic:
3000K - 4200lm - CRI80 (white)

CE IP20 

Recharging method:
Battery charger (IP20)
12V 5Ah

AGATA TAW OOD

Agata Wood è una lampada da interno ed esterno che abbina la moderna tecnologia rotazionale del diffusore in Poleasy alla classicità del treppiede in legno trattato per esterni.

Agata Wood is a lamp suitable for indoor and outdoor use that combines the modern rotational technology used for Poleasy diffuser with classicism of wooden tripod treated for outdoor use.





Piantane Agata Wood
Agata Wood standing lamps



Standing lamp

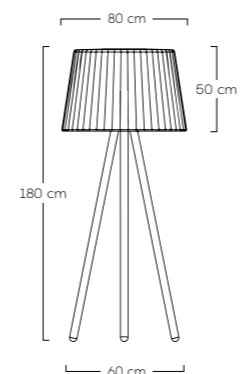

CE IP20

Material:
Poleasy
Wood legs

Packages:
2

Net weight:
13 kg

Volume packaging:
0,34 mc (lampshade)
0,23 mc (structure)

CE IP66

Material:
Poleasy
Wood legs

Packages:
2

Net weight:
13 kg

Volume packaging:
0,34 mc (lampshade)
0,23 mc (structure)

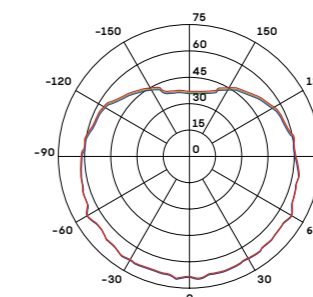

IP44

Finishing e colours:
IL: 110 trasparente

Cable length:
2 mt white cable with plug

Switch:
- ON/OFF switch fitted on the
power cord (IP20)
- Plug (IP44)

Power Input:
110-240V 50/60Hz

Power Consumption:
1x 32W E27

Light source:
Bulb

Characteristic:

CE IP20

Finishing:
IL: 110 trasparente

Cable length:
1,5 mt cable rechargeable

Switch:
Remote control

Power Input:
Adaptor: AC: 100-240V 50/60Hz
DC: 7.5V

Power Consumption:
3,8W

Light source:
RGBW Led

Characteristic:
2700K - 65lm

Recharging time:
6 h.

Duration time:
8-10 h.

AMPO ULE

Una goccia di luce, una forma archetipa e pura che nel suo dinamico slancio racconta l'ineguagliabile poesia del dono di un fiore.

Questo il pensiero ispiratore di un vaso gigante per un unico fiore, un'opera che caratterizza ogni spazio con la sua semplicità, raccontando la magia della sua storia.

Il set comprende anche Ampoule S, per una presenza elegante a centro tavola

A drop of light, an archetypal and pure form that in its dynamic impetus tells of the unique poem of a flower gift.

This is the inspiring thought of a giant vase for a single flower, a work that characterises every space with its simplicity, telling the magic of its history.

The set also includes Ampoule S, an elegant presence in the middle of the table.





Piantane Ampoule XI
Ampoule XI standing lamps



Table

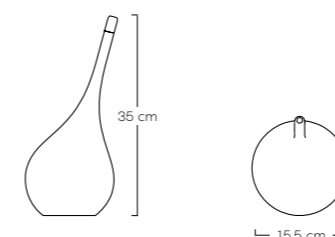

CE IP20

Material:
Poleasy

Net weight:
0,6 kg

Volume packaging:
0,02 mc

Finishing e colours:
IL: 110 trasparente

Cable length:
1,8 mt trasparente cable with plug

Switch:
- ON/OFF switch fitted on the power cord (IP20)

Power Input:
220-240V - 50/60Hz

Power Consumption:
1W

Light source:
G9 Led

Characteristic:
2700K - 55lm

CE IP66

Material:
Poleasy

Net weight:
0,6 kg

Volume packaging:
0,02 mc

Finishing e colours:
IL: 110 trasparente

Cable length:
1,5 mt cable rechargeable

Switch:
Remote control

CE IP20

Power Input:
Adaptor: AC: 100-240V 50/60Hz
DC: 5V

Power Consumption:
1,8W

Light source:
RGBW Led

Characteristic:
2700K - 25lm

Recharging method:
Lithium electric induction

Recharging time:
6 h.

Duration time:
8-10 h.



Standing lamp

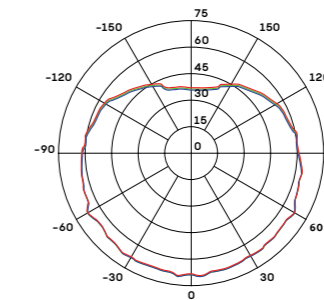
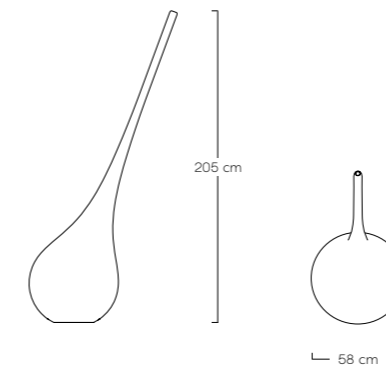

CE IP20

Material:
Poleasy

Net weight:
16 kg

Volume packaging:
0,76 mc

IP20 IP66

Finishing e colours:
IL: 110 trasparente

Cable length:

3 mt trasparente cable with plug (IP20)
2 mt black cable with plug (IP44)

Switch:

- ON/OFF switch fitted on the power cord (IP20)
- Plug (IP44) or connector box (IP66)

Power Input:

110-240V - 50/60Hz

Power Consumption:
1x 32W E27

Light source:
Bulb

Characteristic:

CE IP66

Material:
Poleasy

Net weight:
16 kg

Volume packaging:
0,76 mc

Finishing:
IL: 110 trasparente

Cable length:

1,5 mt cable rechargeable

Switch:

Remote control

CE IP20

Power Input:

Adaptor: AC: 100-240V 50/60Hz
DC: 7.5V

Power Consumption:
3,8W

Light source:
RGBW Led

Characteristic:
2700K - 65lm

Recharging time:
6 h.

Duration time:
8-10 h.

TU LIP

Allegri, informali, casual ed eleganti, sono i Tulip S e Tulip XL le lampade MYYOUR adatte per l'indoor e l'outdoor. Tulip S dalle dimensioni ridotte si adatta agevolmente come lampada di cortesia da tavolo.

Lovely, casual, and smart, Tulip S and Tulip XL are the lamps MYYOUR presents for in and outdoor use.

The first one is really designed as a signal light or courtesy table lamp.





Piantane Tulip XL
Tulip XL standing lamps



Piantane Tulip XL
Tulip XL standing lamps



Table

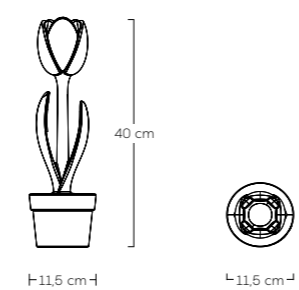

CE IP20

Material:
Poleasy

Net weight:
0,3 kg

Volume packaging:
0,01 mc

Finishing e colours:
IL: 110 trasparente
 388 orange
 404 lilac
 662 green

Cable length:
1,8 mt trasparente cable with plug

Switch:
- ON/OFF switch fitted on the power cord (IP20)

Power Input:
220-240V - 50/60Hz

Power Consumption:
1W

Light source:
G9 Led

Characteristic:
2700K - 55lm



Standing lamp

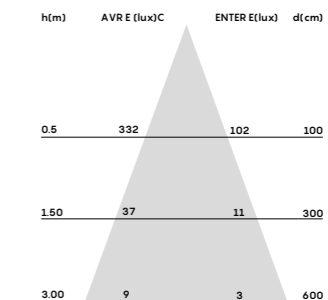
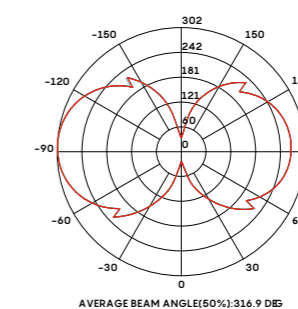
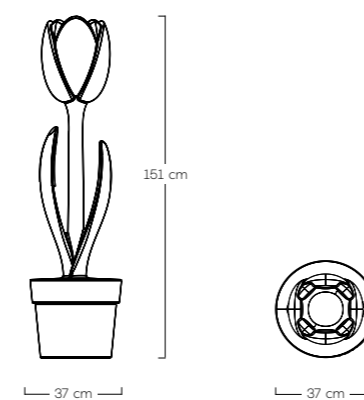

CE IP20

IP44

Material:
Poleasy

Finishing e colours:
IL: 110 trasparente
388 orange
404 lilac
662 green

Net weight:
7 kg

Cable length:
3 mt trasparente cable with plug (IP20)
2 mt black cable with plug (IP44)

Power Input:
220-240V - 50/60Hz
110-277V - 50/60Hz

Volume packaging:
0,22 mc

Switch:
- ON/OFF switch fitted on the power cord (IP20)
- Plug (IP44)

Power Consumption:
28W

Light source:
Fluorescent tube (T528W)

Characteristic:
4000K - 96lm

BABY LOVE

Lampada ornamentale dallo stilizzato profilo di rosa che può assumere diverse forme:

piantana in due altezze, lampada da tavolo, lampadario a soffitto, applique a parete e lampada da esterno nelle versioni waterproof e giardino, dove il suo disegno è pensato per favorire il più rapido e completo smaltimento dell'acqua piovana.

Ornamental stylized lamp with a rose profile that can take several forms:

floor lamp available in two heights, elegant table lamp, ceiling lamp, wall lamps and outdoor lamp in waterproof and garden version, where its design is thought to facilitate the more rapid and complete disposal of rainwater.





Waterproof

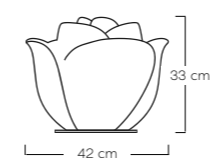

CE IP66

Material:
Poleasy
Stainless steel base

Net weight:
2,6 kg

Volume packaging:
0,10 mc

Finishing e colours:
IL: 110 trasparente

Cable length:
1,5 mt cable rechargeable

Switch:
Remote control

CE IP20

Power Input:
Adaptor: AC: 100-240V 50/60Hz
DC: 5V

Power Consumption:
3,8W

Light source:
RGBW Led

Characteristic:
2700K - 65lm

Recharging method:
Lithium electric induction

Recharging time:
6 h.

Duration time:
8-10 h.



Garden

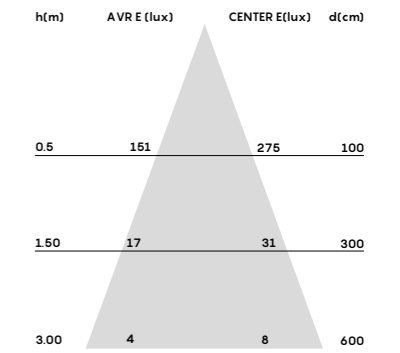
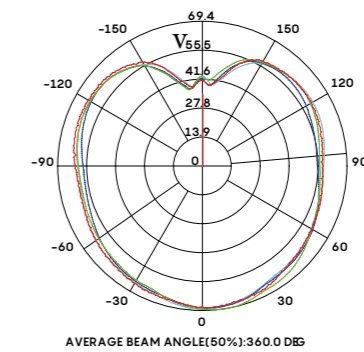
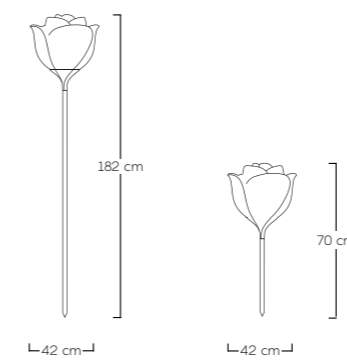

Material:
 Poleasy
 White metal structure

Net weight:
 8,5 kg

Volume packaging:
 0,30 mc

Finishing e colours:
 IL: 110 trasparente

Cable length:
 3 mt trasparente cable with plug (IP20)
 2 mt black cable with plug (IP44)

Switch:
 - ON/OFF switch fitted on the power cord (IP20)
 - Plug (IP44)
 - Connector box (IP66)

Power Input:
 110-240V - 50/60Hz

Power Consumption:
 1x 32W E27

Light source:
 Bulb

Characteristic:



Standing lamp

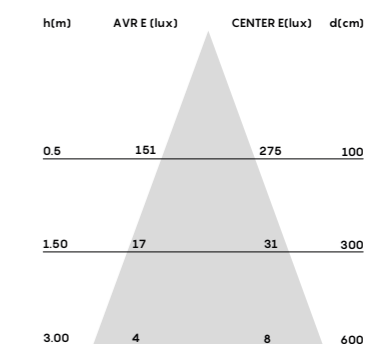
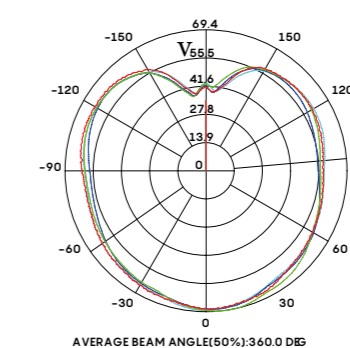
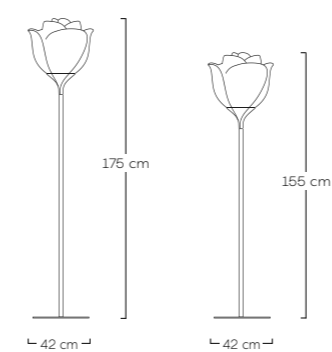

CE IP20

IP44

Material:
Poleasy
White metal structure

Finishing e colours:
IL: 110 trasparente

Net weight:
8,5 kg

Cable length:
3 mt trasparente cable with plug (IP20)
2 mt black cable with plug (IP44)

Power Input:
110-240V - 50/60Hz

Volume packaging:
0,30 mc

Switch:
- ON/OFF switch fitted on the power cord (IP20)
- Plug (IP44) or connector box (IP66)

Power Consumption:
1x 32W E27

Light source:
Bulb

Characteristic:



Wall / Ceiling

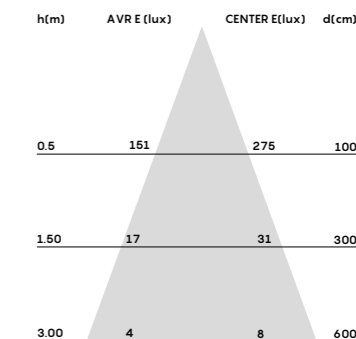
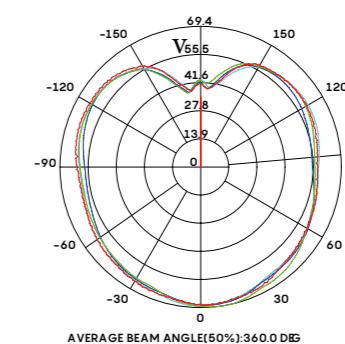
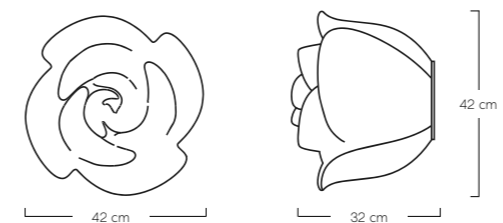

CE IP66

Material:
Poleasy

Net weight:
1,9 kg

Volume packaging:
0,10 mc

Finishing e colours:
IL: 110 trasparente

Cable length:

Switch:

Power Input:
110-240V - 50/60Hz

Power Consumption:
1x 32W E27

Light source:
Bulb

Characteristic:



Suspension

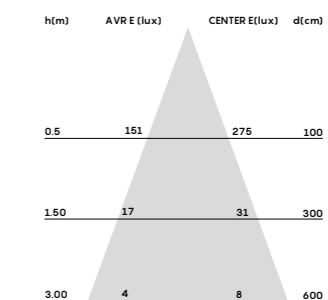
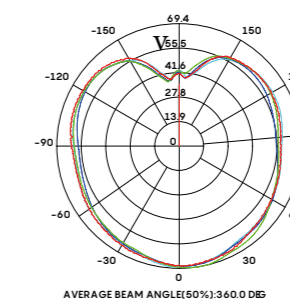
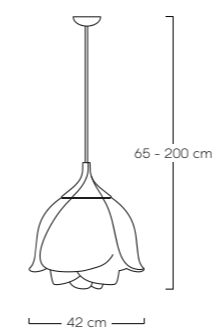

CE IP20

Material:
Polycarbonate
White metal structure

Net weight:
2,6 kg

Volume packaging:
0,10 mc

Finishing e colours:
IL: 110 transparent

Cable length:
1,8 mt transparent cable with plug
(version table)
2 mt transparent cable (version
suspension)

Switch:

Power Input:
110-240V - 50/60Hz

Power Consumption:
1x 32W E27

Light source:
Bulb

Characteristic:



Indoor rose ceiling detail



Table

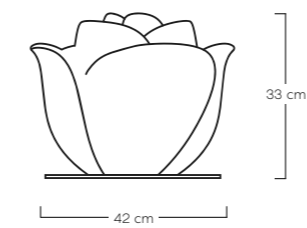

CE IP20 

Material:
Polycarbonate
White metal structure

Net weight:
2,6 kg

Volume packaging:
0,10 mc

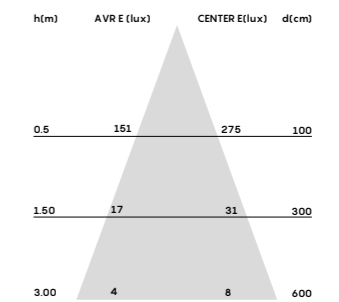
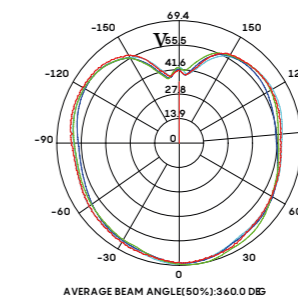

Finishing e colours:
IL: 110 trasparente

Cable length:
1,8 mt trasparente cable with plug
(version table)
2 mt trasparente cable (version
suspension)

Switch:
- ON/OFF switch fitted on the
power cord (IP20)

Power Input:
110-240V - 50/60Hz

Power Consumption:
1x 32W E27

Light source:
Bulb

Characteristic:

PAND ORA

E' la natura ad ispirare le forme di Pandora, che vivono del riverbero della loro texture minimale.

Entità eteree che grazie alle numerose combinazioni cromatiche e finiture creano un set di sedute e tavolini informali.

It's the nature inspiring the shapes of Pandora, that live in the echoes of their minimal texture.

Ethereal entities that thanks to the numerous chromatic combinations and finishing compose a set of informal chairs and tables.





Pandora S e M lampade da terra, piantane Pandora L, divano Modì Zero
Pandora S and M floor lamps, Pandora L standing lamps , Modì Zero sofa.



Lampade a sospensione Pandora S, M, L
Suspension lamps Pandora S, M, L



Standing lamp

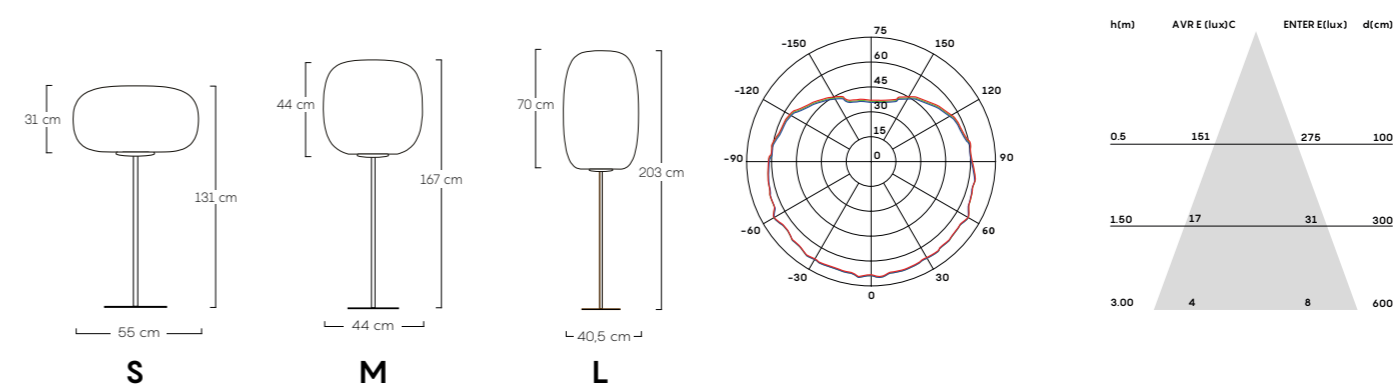

CE IP20 IP44

Material:
Poleasy
White metal structure

Packages:
2

Net weight:
15,5 kg (S)
16 kg (M - L)

Volume packaging:
0,11 + 0,29 mc (S)
0,09 + 0,20 mc (M)
0,12 + 0,21 mc (L)

Finishing e colours:
IL: 110 trasparente

Cable length:
3 mt trasparente cable with plug (IP20)
2 mt white cable with plug (IP44)

Switch:
- ON/OFF switch fitted on the power cord (IP20)
- Plug (IP44)

Power Input:
110-240V - 50/60Hz

Power Consumption:
1x 32W E27

Light source:
Bulb (diam. max 74mm)

Characteristic:



Standing lamp

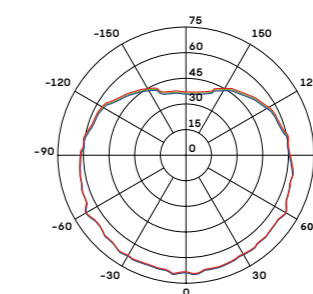
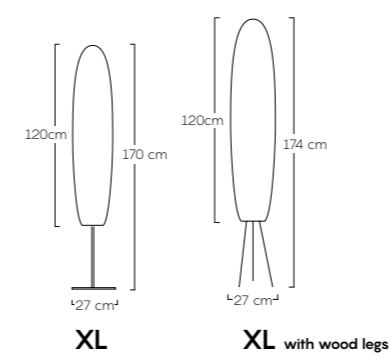

CE IP20   IP44 

Material:
Poleasy
White metal structure
Wood legs

Finishing e colours:
IL: 110 trasparente

Cable length:
3 mt trasparente cable with plug (IP20)
2 mt white cable with plug (IP44)

Power Input:
110-240V - 50/60Hz

Power Consumption:
1x 32W E27

Switch:
- ON/OFF switch fitted on the power cord (IP20)
- Plug (IP44)

Light source:
Bulb (diam. max 74mm)

Characteristic:

Packages:
2

Net weight:
9 kg (XL)
4 kg (XL w/wood legs)

Volume packaging:
0,14 + 0,06 mc (XL)
0,14 + 0,01 mc (XL-wood)



Suspension

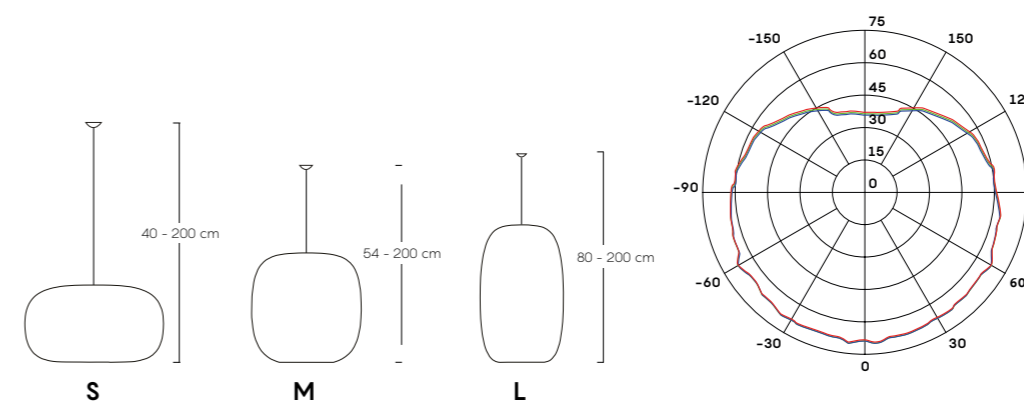

CE IP20 IP66



Material:
Poleasy

Finishing e colours:
IL: 110 trasparente

Cable length:
2 mt transparent cable + suspen-
sion steel wire (IP20)
2 mt black cable

Power Input:
110-240V - 50/60Hz

Packages:
1

Power Consumption:
1x 32W E27

Net weight:
3,5 kg (S)
4 kg (M - L)

Switch:
Connection box (IP66)

Light source:
Bulb

Volume packaging:
0,11 mc (lampshade S)
0,09 mc (lampshade M)
0,12 mc (lampshade L)

Characteristic:

Indoor rose ceiling detail

Outdoor rose ceiling detail





Suspension

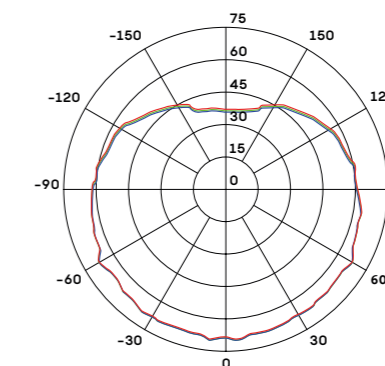
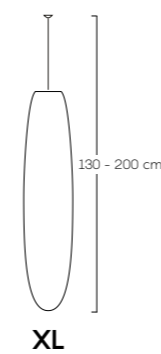

CE IP20 IP66



Material:
Poleasy

Finishing e colours:
IL: 110 trasparente

Packages:
1

Cable length:
2 mt transparent cable + suspen-
sion steel wire (IP20)
2 mt black cable

Power Input:
110-240V - 50/60Hz

Net weight:
3,5 kg (XL)

Switch:
Connection box (IP66)

Power Consumption:
1x 32W E27

Volume packaging:
0,14 mc (lampshade XL)

Light source:
Bulb

Characteristic:

Indoor rose ceiling detail



Outdoor rose ceiling detail





Floor lamp

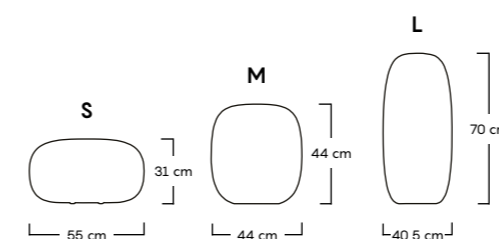

CE IP20 IP44

Material:
Poleasy

Packages:
1

Net weight:
3,5 kg (S)
4 kg (M - L)

Volume packaging:
0,11 mc (lampshade S)
0,09 mc (lampshade M)
0,12 mc (lampshade L)

Finishing e colours:
IL: 110 trasparente

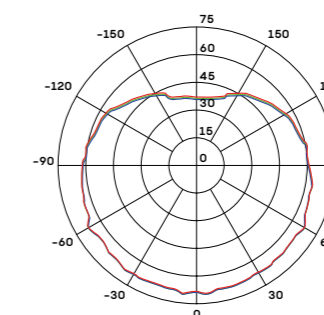

Cable length:
2 mt transparent cable (IP20)
2 mt black cable with plug (IP44)

Switch:
- ON/OFF switch fitted on the power cord (IP20)
- Plug (IP44)

Power Input:
110-240V - 50/60Hz

Power Consumption:
1x 32W E27

Light source:
Bulb

Characteristic:



Floating

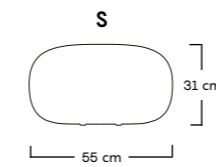

CE IP66

Material:
Poleasy

Packages:
1

Net weight:
3,5 kg (S)

Volume packaging:
0,11 mc

IP44

Finishing e colours:
IL: 110 trasparente

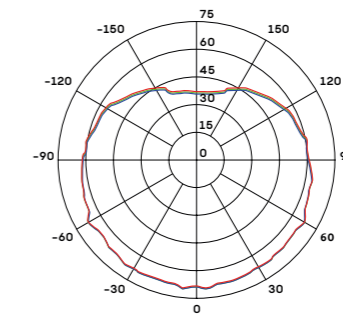

Cable length:
1,5 mt cable rechargeable

Switch:
Remote control

CE IP20

Power Input:

Adaptor:
AC: 100-240V 50/60Hz
DC: 5V

Power Consumption:
3,8W

Light source:
RGBW Led

Characteristic:
2700K - 65lm

Recharging method:
Lithium electric induction

Recharging time:
6 h.

Duration time:
8-10 h.

E L
I N





Elin single light suspension

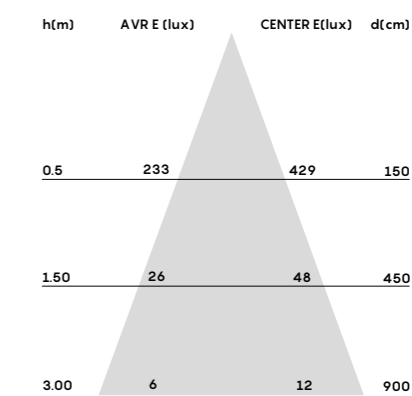
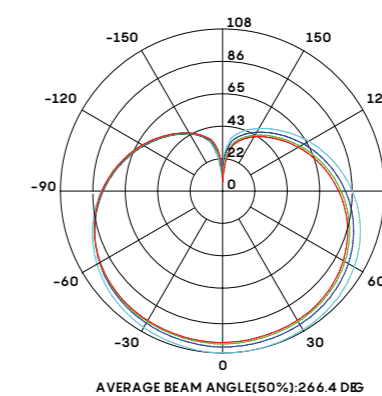
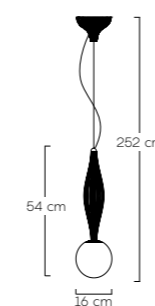

CE IP20 IP66



Material:

Poleasy

Packages:

1

Net weight:

0,6 kg

Volume packaging:

0,02 mc

Finishing e colours:

GS: 602 Ivory
617 light grey
759 marsala

Lampshade available only 110 transparent colour.

OV: 177 pearly copper
52 gold
150 light blue

Cable length:

2 mt transparent cable + suspension steel wire
2 mt black cable

Switch:

Connection box

Power Input:

110-270V - 50/60Hz

Power Consumption:

10W

Light source:

Led plate

Characteristic:

4000K - 1100lm - CRI80

Ceiling rose detail





Suspension

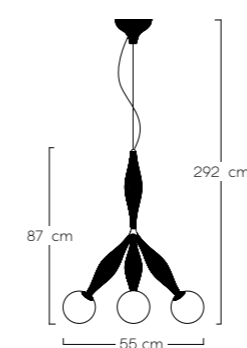

CE IP20 IP66



Material:

Poleasy

Packages:

1

Net weight:

2,5 kg

Volume packaging:

0,25 mc

Finishing e colours:

GS: 602 Ivory
617 light grey
759 marsala

Lampshade available only 110 transparent colour.

OV: 177 pearly copper
52 gold
150 light blue

Cable length:

2 mt transparent cable + suspension steel wire
2 mt black cable

Switch:

Connection box

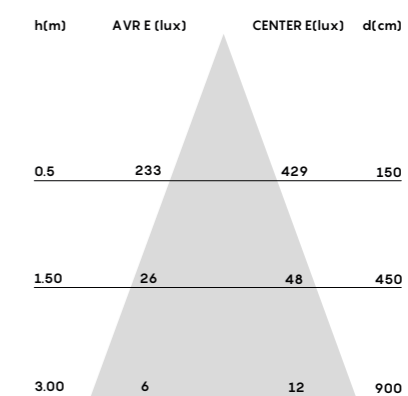

Ceiling rose detail





Suspension

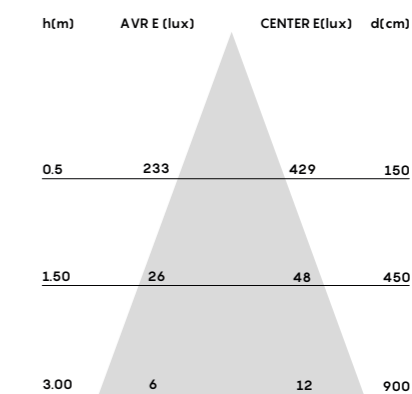
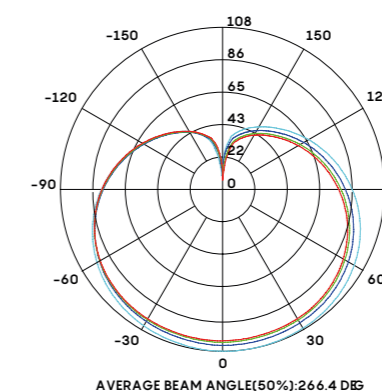
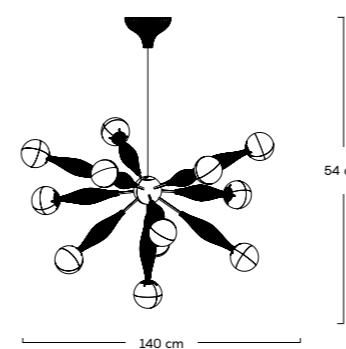

CE IP20 IP66

Material:
Poleasy
Matt black metal

Packages:
1

Net weight:
10 kg

Volume packaging:
0,19 mc

Finishing e colours:
GS: 602 Ivory
617 light grey
759 marsala

Lampshade available only 110 transparent colour.

OV: 177 pearly copper
52 gold
150 light blue

Cable length:
2 mt black cable+ suspension steel wire

Switch:
Connection box

Power Input:
110-270V - 50/60Hz

Power Consumption:
10W

Light source:
Led plate

Characteristic:
4000K - 1100lm - CRI80

Ceiling rose detail





Standing lamp

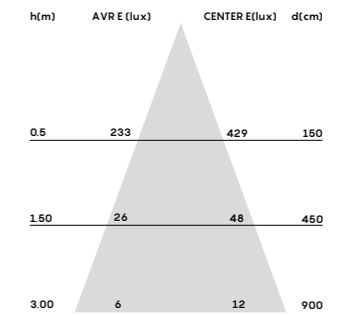
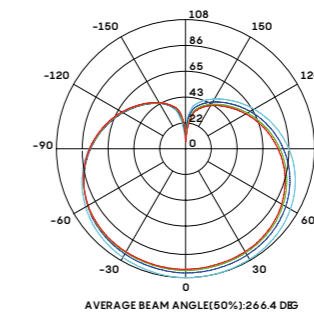
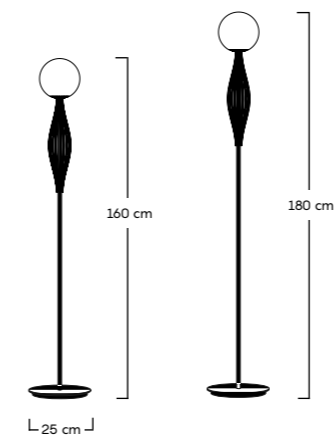

CE IP20 IP44

Material:
Poleasy
Matt black aluminium structure

Packages:
1

Net weight:
8 kg

Volume packaging:
0,10 mc (h160)
0,12 mc (h180)

Finishing e colours:
GS: 602 Ivory
617 light grey
759 marsal

Lampshade
available only 110
transparent colour.

OV: 177 pearly copper
52 gold
150 light blue

Cable length:
3 mt trasparent cable with plug
(IP20)
2 mt black cable with plug (IP44)

Switch:
- ON/OFF switch fitted on the
power cord (IP20)
- Plug (IP44)

Power Input:
110-270V - 50/60Hz

Power Consumption:
10W

Light source:
Led plate

Characteristic:
4000K - 1100lm - CRI80

NE FOS





Sospensioni Nefos
Nefos suspensions

Cuscini Morfeo
Morfeo pillows

Tappeti Teo
Teo rugs



Suspension

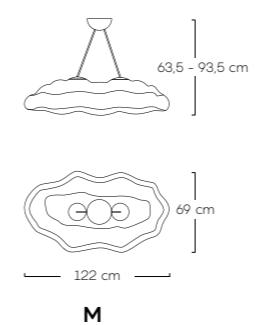

M

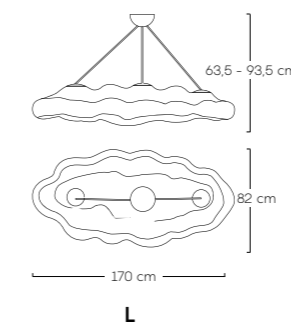

L

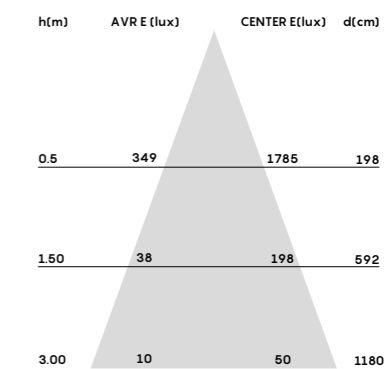
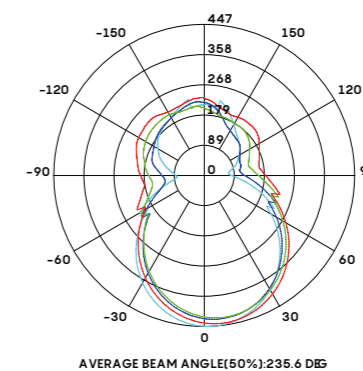

CE IP20 IP66



Material:
Poleasy

Finishing e colours:
IL: 110 transparent

Cable length:
2 mt white cable

Power Input:
110-270V 50/60Hz

Net weight:
7 kg (Nefos M)
10 kg (Nefos L)

Switch:
Connection box

Power Consumption:
2x32W E27 (Nefos M)
3x 32W E27 (Nefos L)

Volume packaging:
0,24 mc (Nefos M)
0,45 mc (Nefos L)

Light source:
Bulb

Characteristic:

Ceiling rose detail



FUNNEL





Sospensioni Funnel S e L
Funnel S e L suspensions



Sospensioni Funnel L nella finitura OS ossidato rame
Funnel L suspensions lamp in OS oxidated copper finishing



Suspension

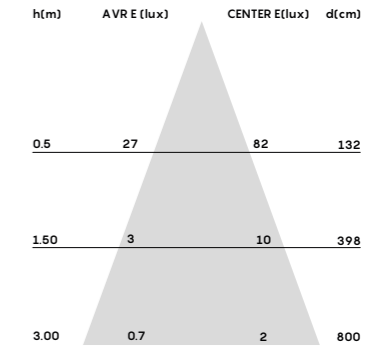
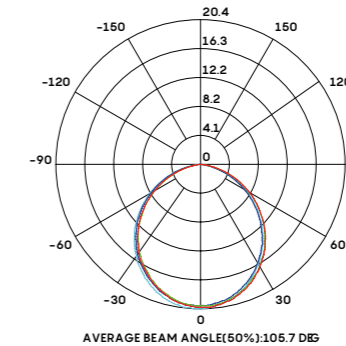
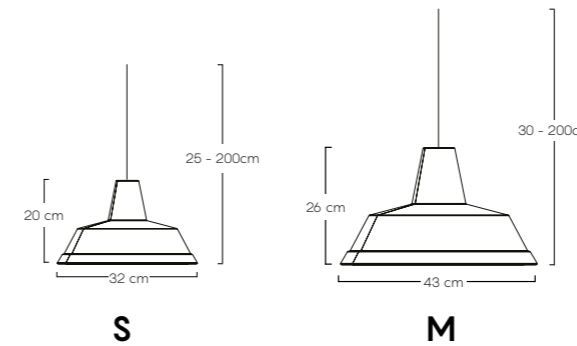

CE IP44 IP66



Material:
Poleasy

Finishing e colours:
IL: 110 transparent

Net weight:
1 kg (Funnel S)
2 kg (Funnel M)
3,5 kg (Funnel L)

VP: 162 dark pearl
150 light blue
500 rust
101 copper

Volume packaging:
0,018 mc (Funnel S)
0,070 mc (Funnel M)

Cable length:
2 mt black cable
6mt black cable with plug (ver-
sion portable, IP44)

Power Input:
220-240V 50/60Hz

Power Consumption:
5W (Funnel S - M)

Switch:
Connection box

Light source:
G9 Led

Characteristic:
3000K - 330lm (Funnel S - M)

Ceiling rose detail





Suspension

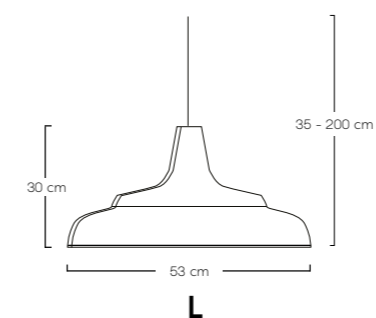

CE  IP44 IP66

Material:
Poleasy

Net weight:
3,5 kg (Funnel L)

Volume packaging:
0,15 mc (Funnel L)



Finishing e colours:
IL: 110 transparent

VP: 162 dark pearl
150 light blue
500 rust
101 copper

L battery version

CE  IP66

Material:
Poleasy

Net weight:
3,5 kg

Volume packaging:
0,11 mc

Finishing e colours:
IL: 110 transparent

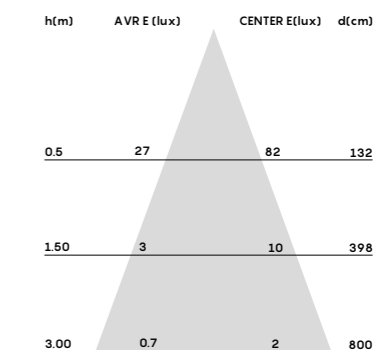
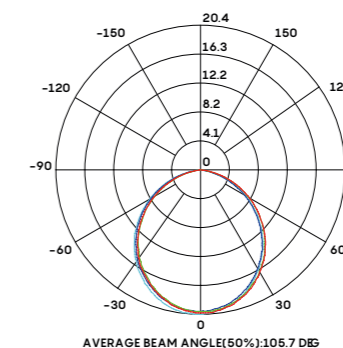

Cable length:

2 mt black cable
6mt black cable with plug
(version portable, IP44)

Switch:

Connection box

Power Input:

220-240V 50/60Hz

Power Consumption:

1x 32W E27 (Funnel L)

Light source:

G9 Led
Bulb (Funnel L)

Characteristic:

CE  IP20

Power Input:

Adaptor: AC: 100-240V 50/60Hz
DC: 5V

Power Consumption:

3,8W

Light source:

RGBW Led

Characteristic:

2700K - 65lm

Recharging method:

Lithium electric induction

Recharging time:

6 h.

Duration time:

8-10 h.

BELL

Bell lights è una linea di 3 lampade S, M e L realizzata in Poleasy rotazionale adatta all'utilizzo interno ed esterno.

Il design segue il filone industriale, così come la verniciatura vintage painting che grazie all'irregolarità della micro punti- natura e alla ombreggiatura accentuano il concetto vintage replicando l'effetto del tempo che scorre, rendendo ogni singolo articolo irripetibile.

La versione non verniciata per alcune misure è disponibile oltre al modello lampada a sospensione e lampada portatile con spina anche con kit RGBW a batteria.

Bell lights is a line of three lamps S, M and L made of rotational Poleasy suitable for indoor and outdoor use.

The design follows the "industrial" trend, as well as vintage painting which thanks to the irregularity of micro dots and shading, accentuates the vintage concept by replicating the effect of passing time, making unique every single item.

In addition to the suspension model, for some sizes, the unpainted version is also available as portable lamp with plug or with RGBW battery kit.



Sospensioni Bell L
Bell L suspensions





Sospensioni Bell S e M, Bell S portatile con cavo
Bell S and M suspensions, Bell S portable with plug



Suspension / portable with plug

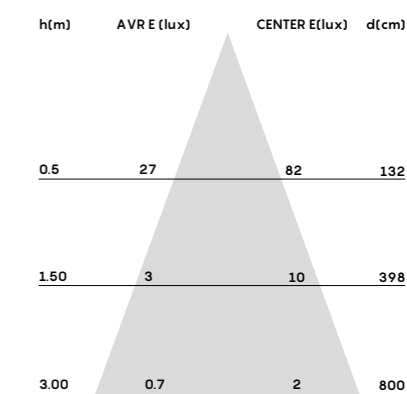
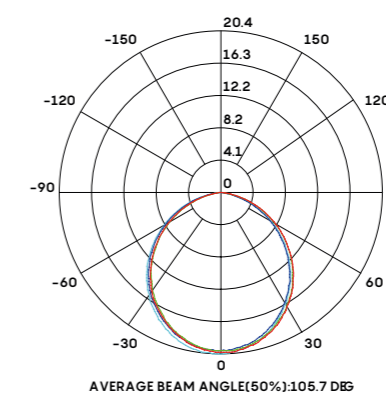
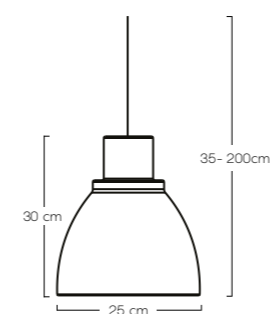

CE IP44 IP66



Material:
Poleasy

Finishing e colours:
IL: 110 transparent

Net weight:
1 kg (Bell S)

VP: 162 dark pearl
150 light blue
500 rust
101 copper

Volume packaging:
0,018 mc (Bell S)

Cable length:
2 mt black cable
6mt black cable with plug
(version portable, IP44)

Power Input:
220-240V 50/60Hz

Power Consumption:
5W (Bell S)

Switch:
Connection box

Light source:
G9 Led

Characteristic:
3000K - 330lm (Bell S)

Ceiling rose detail





Suspension / portable with plug

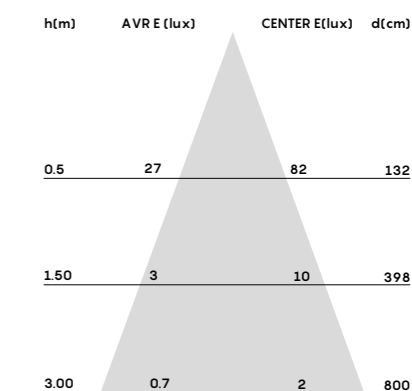
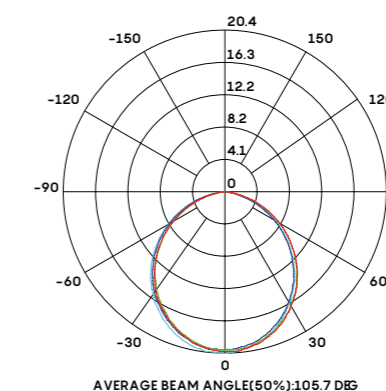
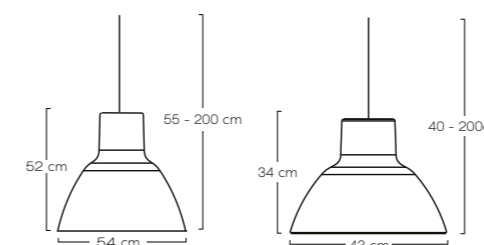

CE IP44 IP66



Material:
Poleasy

Finishing e colours:
IL: 110 transparent

Cable length:
2 mt black cable
6mt black cable with plug
(version portable, IP44)

Power Input:
220-240V 50/60Hz

Net weight:
2 kg (Bell M)
3,5 kg (Bell L)

VP: 162 dark pearl
150 light blue
500 rust
101 copper

Switch:
Connection box (IP 66)

Power Consumption:
1x 32W E27 (Bell M - L)

Volume packaging:
0,070 mc (Bell M)
0,15 mc (Bell L)

Light source:
G9 Led
Bulb (Bell L)

Characteristic:

M - L battery version

CE IP66

Material:
Poleasy

Finishing e colours:
IL: 110 transparent

Cable length:
1,5 mt cable rechargeable

CE IP20

Power Input:
Adaptor: AC: 100-240V 50/60Hz
DC: 5V

Net weight:
3,5 kg

Switch:
Remote control

Power Consumption:
3,8W

Volume packaging:
0,11 mc

Light source:
RGBW Led

Characteristic:
2700K - 65lm

Recharging method:
Lithium electric induction

Recharging time:
6 h.

Duration time:
8-10 h.

BONSAI





Lampada da tavolo bonsai
Bonsai table lamp



Table

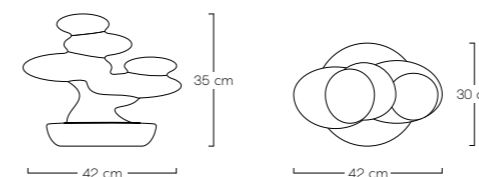

CE  IP20



 IP44



Material:
Poleasy

Finishing e colours:
IL: 110 trasparente

Net weight:
1,7 kg

Volume packaging:
0,10 mc

Cable length:
2 mt transparent cable with plug (IP20)
2 mt black cable with plug (IP44)

Switch:
- ON/OFF switch fitted on the power cord (IP20)
- Plug (IP44)

Power Input:
AC: 170-250V 50/60Hz
DC: 12V 1A

Power Consumption:
4,8W

Light source:
Strip Led

Characteristic:
5800/6500K - 880lm - CRI80

CE  IP66

Material:
Poleasy

Net weight:
3,5 kg

Volume packaging:
0,11 mc

Finishing e colours:
IL: 110 trasparente

Cable length:
1,5 mt cable rechargeable

Switch:
Remote control

CE   IP20 

Power Input:
Adaptor: AC: 100-240V 50/60Hz
DC: 5V

Power Consumption:
3,8W

Light source:
RGBW Led

Characteristic:
2700K - 65lm

Recharging method:
Lithium electric induction

Recharging time:
6 h.

Duration time:
8-10 h.

CR
YS
TA
L





Floor lamp

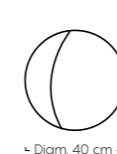

Diam: 40 cm

40

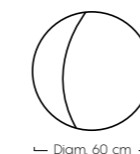

Diam: 60 cm

60

CE IP20

Material:
Poleasy

Packages:
1

Net weight:
1,5 kg (Crystal40)
4 kg (Crystal60)

Volume packaging:
0,06 mc (Crystal40)
0,21 mc (Crystal60)

Floor lamp version battery

CE IP66

Material:
Poleasy

Net weight:
3,5 kg

Volume packaging:
0,11 mc

IP44 IP66

Finishing e colours:
IL: 110 trasparente

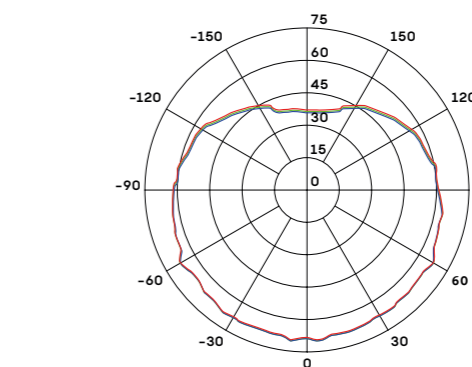

Cable length:

2 mt transparent cable
2 mt black cable with plug (IP44)

Switch:

ON/OFF switch fitted on the power cord (IP20)
Plug (IP44) or connector box (IP66)

Power Input:

110-240V - 50/60Hz

Power Consumption:

1x 32W E27

Light source:

Bulb

Characteristic:

Finishing e colours:
IL: 110 trasparente

Cable length:

1,5 mt cable rechargeable

Switch:

Remote control

CE IP20

Power Input:

Adaptor: AC: 100-240V 50/60Hz
DC: 5V

Power Consumption:

3,8W

Light source:

RGBW Led

Characteristic:

2700K - 65lm

Recharging method:

Lithium electric induction

Recharging time:

6 h.

Duration time:

8-10 h.



Floor lamp

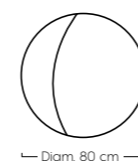

80

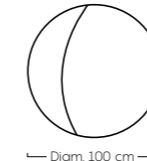

100

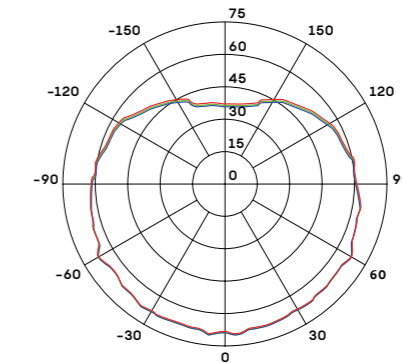

CE IP20

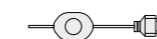

IP44 IP66

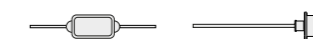

Material:
Poleasy

Finishing e colours:
IL: 110 trasparente

Cable length:
2 mt transparent cable
2 mt black cable with plug (IP44)

Power Input:
110-240V - 50/60Hz

Packages:
1

Net weight:
6 kg (Crystal80)
11 kg (Crystal100)

Switch:
ON/OFF switch fitted on the power cord (IP20)
Plug (IP44) or connector box (IP66)

Power Consumption:
1x 32W E27

Light source:
Bulb

Characteristic:

Volume packaging:
0,51 mc (Crystal80)
1 mc (Crystal100)

Floor lamp version battery

CE IP66

Material:
Poleasy

Finishing e colours:
IL: 110 trasparente

Cable length:
1,5 mt cable rechargeable

CE IP20

Power Input:
Adaptor: AC: 100-240V 50/60Hz
DC: 5V

Net weight:
3,5 kg

Switch:
Remote control

Power Consumption:
3,8W

Light source:
RGBW Led

Characteristic:
2700K - 65lm

Recharging method:
Lithium electric induction

Recharging time:
6 h.

Duration time:
8-10 h.



Suspension

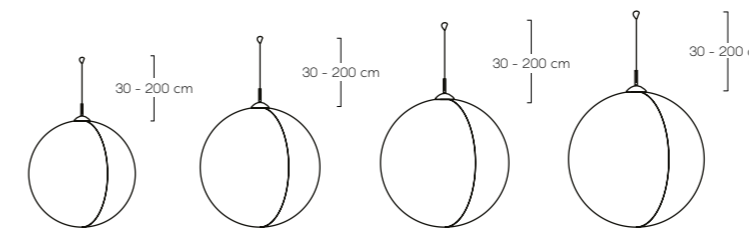

CE IP20

IP44

IP66



Material:
Poleasy

Finishing e colours:
IL: 110 trasparente

Cable length:
2 mt transparent cable
2 mt black cable

Power Input:
110-240V - 50/60Hz

Packages:
1

Switch:
Connection box (IP66)

Power Consumption:
1x 32W E27

Net weight:
1,5 kg (Crystal40)
4 kg (Crystal60)
6 kg (Crystal80)
11 kg (Crystal100)

Light source:
Bulb

Characteristic:

Volume packaging:
0,06 mc (Crystal40)
0,21 mc (Crystal60)
0,51 mc (Crystal80)
1 mc (Crystal100)

Indoor rose ceiling detail

Outdoor rose ceiling detail



TRE
ES
MU
ST





Lampada da terra Treesmust e Crystal 40, 60 e 80
 Treesmust and Crystal 40, 60 and 80 floor lamps



Floor lamp

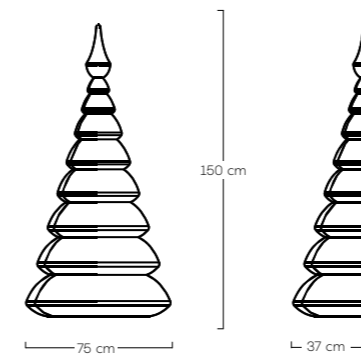

CE IP20

Material:
Poleasy

Packages:
1 (2pcs/box)

Net weight:
6,5 kg

Volume packaging:
0,43 mc



Finishing e colours:
IL: 110 trasparente

Floor lamp version battery

CE IP66

Material:
Poleasy

Packages:
1 (2pcs/box)

Net weight:
6,5 kg

Volume packaging:
0,43 mc

Finishing e colours:
IL: 110 trasparente

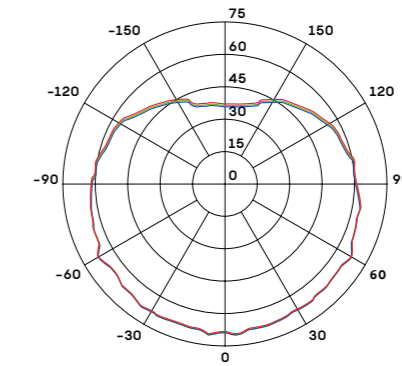
**Cable length:**

2 mt transparent cable
2 mt black cable with plug (IP44)

Switch:

- ON/OFF switch fitted on the
power cord (IP20)
- Plug (IP44)

Power Input:

110-240V - 50/60Hz

Power Consumption:

1x 32W E27

Light source:

Bulb

Characteristic:**Cable length:**

1,5 mt cable rechargeable

Switch:

Remote control

CE IP20

Power Input:

Adaptor: AC: 100-240V 50/60Hz
DC: 5V

Power Consumption:

3,8W

Light source:

RGBW Led

Characteristic:

2700K - 65lm

Recharging method:

Cable rechargeable

Recharging time:

6 h.

Duration time:

8-10 h.

L
I
G
H
T
T
A
L
E
S



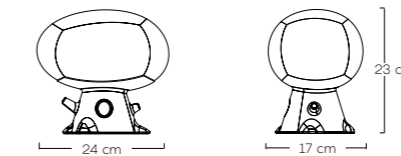
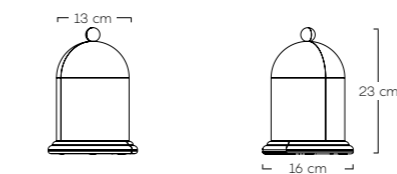
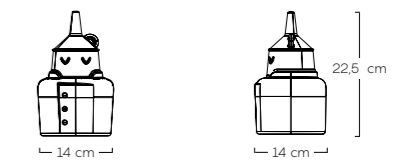
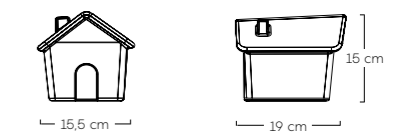

Lampade Mobi XL e divano Nova S
Mobi XL lamps and Nova S sofa

**Table****Mobi****Cat****Rose****Tin****Tri**

CE IP20

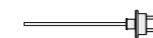
**Material:**
Poleasy**Finishing e colours:**
IL: 110 trasparente**Net weight:**
0,6 kg**Volume packaging:**
0,02 mc**Cable length:**
1,8 mt trasparente cable with plug**Switch:**
- ON/OFF switch fitted on the power cord (IP20)**Power Input:**
220-240V - 50/60Hz**Power Consumption:**
1W**Light source:**
G9 Led**Characteristic:**
2700K - 55lm

Table

Mobi

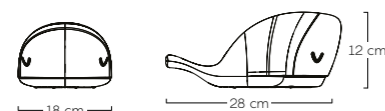

Cat

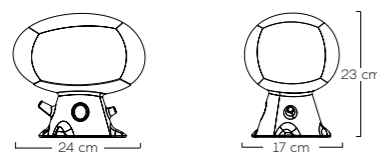

Rose

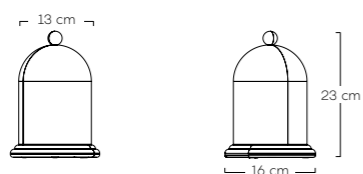

Tin

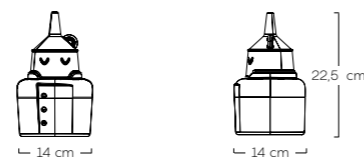

Tri

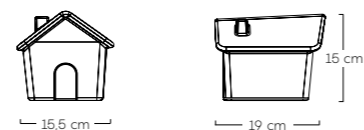

version battery

CE IP66

Material:
Poleasy

Net weight:
0,6 kg

Volume packaging:
0,02 mc

Finishing e colours:
IL: 110 trasparente

Cable length:
1,5 mt cable rechargeable

Switch:
Remote control

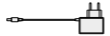
CE IP20 

Power Input:
Adaptor: AC: 100-240V 50/60Hz
DC: 5V

Power Consumption:
3,8W

Light source:
RGBW Led

Characteristic:
2700K - 65lm

Recharging method:
Cable rechargeable

Recharging time:
6 h.

Duration time:
8-10 h.



TECH INDEX

Finiture e colori
Finishes and colors

IL - Illuminable
171 - 172

OV - Direct Painting
173 - 174

Designer

Designer
174 - 175

ILLUMINABLE





- 

transparent 110
- 

yellow 612
- 

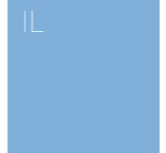
orange 388
- 

lilac 404
- 

light blue 5513
- 

green 662

Per conoscere i colori disponibili di ogni articolo consultare il listino prezzi.
 To know the available colours for each items, please check the price list.

DIRECT PAINTING



pink 3380

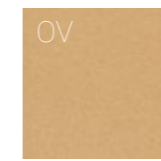

gold 52



light blue 150

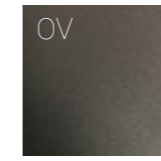

graphite 9405

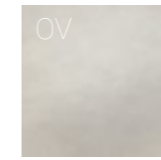

pearl gray 180



dark pearl 162



pearly copper 177

Per conoscere i colori disponibili di ogni articolo consultare il listino prezzi.
 To know the available colours for each items, please check the price list.

PAOLO DE LUCCHI

About

Born in 1980 in Verona and graduated in Industrial Design at Politecnico di Milano, after a three years collaboration with Ludovica+Roberto Palomba in Milan, in 2007 he setup his own studio in Verona where he works with other professionals in architecture, communication and graphics. His works have been showcased in many expositions in Rome, Milan, New York, Paris, São Paulo, Miami, London and Dubai. His works have been featured by NY Times, Herald Tribune, Abitare, Interni, Ottagono, Residence, Icon, Elle Decor, Rolling Stone.

Products

Nefos



BROGLIATO TRAVERSO

About

Alberto Brogliato and Federico Traverso founded BrogliatoTraverso design studio in 2014. Their approach to design is 'NO TIME, NO SPACE' and refers to ideate objects with a timeless design. BrogliatoTraverso work by creating a detailed sign, but almost invisible. With these finely hinted forms, their creations establish deep intimate empathy with the users and their surroundings, respecting both of them. Their fine simplification process delivers projects addressing the needs of consumers and made for various companies, including Cappellini, Fratelli Guzzini, Infiniti, Il Fanale/Torremato, Myyour. The Studio won many international awards, including the Red Dot Design Award, German Design Award, IF Design Award and Good Design Award.

Products

Mobi
Ampoule
Pandora Collection
Treesmust
Hollywood



www.brogliatotraverso.com

MORE DESIGN

About

Moredesign, a company based in Padua founded in 2007, which deals with industrial design in line with market needs following the client's requests. Our experience allows us to offer all the creative and design contribution to companies that want to stand out by offering multidisciplinary design. We follow the company and the product in all its development phases by applying innovation in the forms, tightening the designer-company combination giving the guarantee of the final result. We have worked with the most important Italian and foreign brands and our products are present and exported all over the world. We are able to rationalize an idea and always have a lateral thinking, with a single objective: to put man and his needs at the center of every project.

Products

Tulip
Penelope
Agata
Agata wood



ANGELETTI & RUZZA

About

After receiving their Degrees in Industrial Design from I.S.I.A. in Rome, Silvana Angeletti and Daniele Ruzza opened their design studio: angeletti ruzza design. They work with Italian companies such as: TEUCO, FLAMINIA, AZZURRA, FLLI FANTINI, GUZZINI, COLOMBO DESIGN, IRSAP, SERAFINO ZANI, NEMO, POLTRONA FRAU, GEDY, GRAFF, GEL, INDESIT COMPANY, HOTPOINTILLY, FIAM, OLUCE, BRILLIANT, MY HOME COLLECTION, DAA, HARSA, HAMAT, LONDON ART, BRAID, KALON.

Products

Elin



www.angelettiruzza.com



MYYOUR®

www.myyour.eu